

Three Mode WiFi Switch

Model: TYWB-4CH 7-32V RF

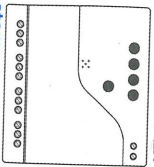

Parameters:

- Input Voltage: DC 7V-32V or USB 5V
- Max Current: 2000mA/10A/0gang
- Max Load: 3500W/16A/4gang
- Wireless-Wi-Fi 2.4ghz b/g/n Bluetooth
- Radio Frequency: 433MHz
- Working Temperature: -20°C~70°C
- Size: 75*73*20mm

Checklist before using the device

- Your smart phone or tablet has connected to a 2.4g WiFi with internet.
- You need to enable Bluetooth of the phone.
- You have the correct WiFi PWD.
- You smart phone or tablet must have access to App store/Google play.
- Your router is MAC-open.

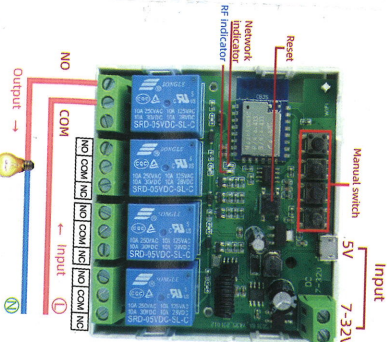

User Guide

- You can download the App by searching "Tuya Smart" in mobile app stores or scanning the following QR code



- Register an Tuya Smart account. Just login.

Add devices

- Reset the device first:
 - if the network indicator (red light) blinking fast ① for 10 seconds.
 - hold down the Reset button for 5 seconds.
 - until network indicator (red light) blinking fast, make your device entered pairing mode.
- Clicking ② in the top right corner on Tuya smart app, wait a few seconds, after the devices are found, click "Add".

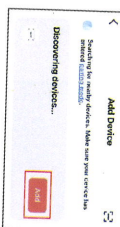

- Select a 2.4GHz Wi-Fi network and enter your password.

Name your device.



- When the network is disconnected, the switch will automatically switch to the Bluetooth control of the phone.
- Click the on/off buttons on the App can control device. Manual control switch also can be display real-time on the App.

APP Function

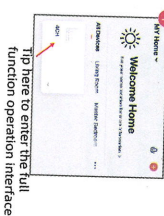

Tip here to enter the full function operation interface.

- Rename /Offline Notification /Share Device /Remove the device /Rename Device

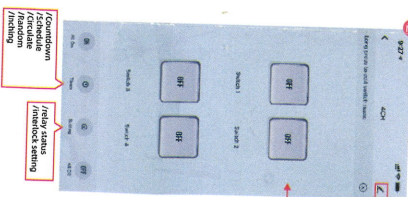

Long press the switch icon to share the device and icon

Remote control matches the code



- Matching:
- hold the manual switch for 3 seconds you will get the remote control for indicator (blue light) is on.
 - then long press the remote control button you want to match.
 - press other buttons, repeat steps ① to ③, matching success.
 - Long press the manual switch for 15 seconds you want to clear (RF) putting indicator is always on, until RF indicator (blue light) is off, then loosen the manual switch.

TRUBLESHOOTING

Enter the homepage of App, click the icon in the lower right corner of the interface to enter.

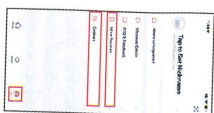

Touch Access Controller and Reader

Please read the manual carefully before use this unit

1. Packing List

Name	Quantity	Remarks
Keypad	1	
User manual	1	
Screw driver	1	Φ20mm×60mm,Special for keypad
Rubber plug	2	Φ6mm×30 mm, used for fixing
Self tapping screws	2	Φ4mm×28 mm, used for fixing
Star screws	1	Φ3mm×6mm, used for fixing

Please ensure that all the above contents are correct. If any are missing please notify the supplier of the unit.

2. Quick Reference Programming Guide

To enter the programming mode	<input type="text" value="#"/> <input type="text" value="Master code"/> <input type="text" value="#"/> 999999 is the default factory master code
To exit from the programming mode	<input type="text" value="*"/>
Note that to undertake the following programming the master user must be logged in	
To change the master code	<input type="text" value="1"/> <input type="text" value="New code"/> <input type="text" value="#"/> <input type="text" value="New code"/> <input type="text" value="#"/> The master code can be 6 to 8 digits
To add a PIN user	<input type="text" value="1"/> <input type="text" value="User ID number"/> <input type="text" value="#"/> <input type="text" value="PIN"/> <input type="text" value="#"/> The ID number is any number between 1 & 2000. The PIN is any four digits between 0000 & 9999 with the exception of 1234 which is reserved. Users can be added continuously without exiting programming mode
To add a card user	<input type="text" value="1"/> <input type="text" value="Read Card"/> <input type="text" value="#"/> Cards can be added continuously without exiting programming mode
To delete a PIN or a card user.	<input type="text" value="2"/> <input type="text" value="User ID number"/> <input type="text" value="#"/> for a PIN user or <input type="text" value="2"/> <input type="text" value="Read Card"/> <input type="text" value="#"/> for a card user Users can be deleted continuously without exiting programming mode
To unlock the door for a PIN user	Enter the <input type="text" value="PIN"/> then press <input type="text" value="#"/>
To unlock the door for a card user	Present the card

3. Description

The unit is single door multifunction standalone access controller or a Wiegand output keypad or card reader. It is suitable for mounting either indoor or outdoor in harsh environments. It is housed in a strong, sturdy and vandal proof Zinc Alloy electroplated case which is available in either a bright silver or matt silver finish. The electronics are fully potted so the unit is waterproof and conforms to IP68. This unit supports up to 2000 users in either a Card, 4 digit PIN, or a Card + PIN option. The inbuilt card reader supports 125KHZ EM cards, 13.56MHz Mifare cards. The unit has many extra features including lock output current short circuit protection, Wiegand output, and a backlit keypad. These features make the unit an ideal choice for door access not only for small shops and domestic households but also for commercial and industrial applications such as factories, warehouses, laboratories, banks and prisons.

4. Features

- Waterproof and conforms to IP68
- Strong Zinc Alloy Electroplated anti-vandal case
- Full programming from the keypad
- 2000 users, supports Card, PIN, Card + PIN
- Can be used as a standalone keypad
- Backlight keys
- Wiegand 26 input for connection to external reader
- Wiegand 26 output for connection to a controller
- Adjustable Door Output time, Alarm time, Door Open time
- Very low power consumption (30mA)
- Fast operating speed, <20ms with 2000 users
- Lock output current short circuit protection
- Easy to install and program
- Built in light dependent resistor (LDR) for anti tamper
- Built in buzzer
- Red, Yellow and Green LEDs display the working status

5. Specifications

Operating Voltage	DC 12V±10%
User Capacity	2000
Card Reading Distance	3-6 cm
Active Current	<60mA
Idle Current	25±5 mA
Lock Output Load	Max 3A
Alarm Output Load	Max 20A
Operating Temperature	-45℃~60℃
Operating Humidity	10%- 90% RH
Adjustable Door Relay time	0-99 seconds

Adjustable Alarm Time	0- 3 minutes
Wiegand Interface	Wiegand 26 bit
Wiring Connections	Electric Lock, Exit Button, External Alarm, External reader

6. Installation

- Remove the back cover from the keypad using the supplied special screw driver
- Drill 2 holes on the wall for the Self tapping screws and 1 hole for the cable
- Put the supplied rubber bungs to into the two holes
- Fix the back cover firmly on the wall with 2 Self tapping screws
- Thread the cable through the cable hole
- Attach the keypad to the back cover.

7. Wiring

Colour	Function	Description
Pink	BELL_A	Doorbell button one end
Pink	BELL_B	Doorbell button to the other end
Green	D0	WG output line D0
White	D1	WG output line D1
Grey	ALARM	Alarm negative(alarm positive connected 12 V+)
Yellow	OPEN	Exit button one end(the other end connected GND)
Brown	D_IN	Magnetic switch one end(the other end connected GND)
Red	12V+	12V + DC Regulated Power Input
Black	GND	12V - DC Regulated Power Input
Blue	NO	Relay normally-on end(Connect positive electric lock "-")
Purple	COM	Relay Public end, connect GND
Orange	NC	Relay Closed end(Connect negative electric lock "-")

common power supply diagram:

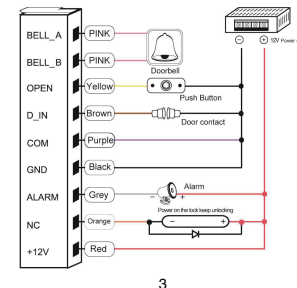

special power supply diagram:

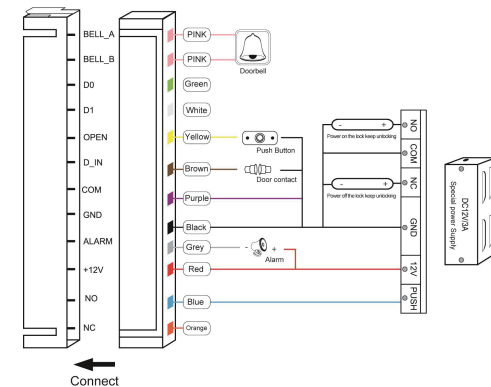

8. To Reset to Factory Default

- Disconnect power from the unit
- Press and hold # key whilst powering the unit back up
- On hearing two "Di" release # key, system is now back factory settings

Please note only installer data is restored, user data will not be affected

9. Anti Tamper Alarm

The unit uses a LDR (light dependent resistor) as an anti tamper alarm. If the keypad removed from the cover then the tamper alarm will operate.

10. Sound and Light indication

Operation Status	Red Light	Green Light	Yellow Light	Buzzer
Power on	-	Bright	-	Di
Stand by	Bright	-	-	-
Press keypad	-	-	-	Di
Operation successful	-	Bright	-	Di
Operation failed	-	-	-	DiDiDi
Enter into programming mode	Bright	-	-	-
In the programming mode	-	-	Bright	Di
Exit from the programming mode	Bright	-	-	Di
Open the door	-	Bright	-	Di
Alarm	Bright	-	-	Alarm

11. Detailed Programming Guide

11.1 User Settings

To enter the programming mode	* Master code # 999999 is the default factory master code
To exit from the programming mode	*
Note that to undertake the following programming the master user must be logged in	
To change the master code	0 New code # New code # The master code can be 6 to 8 digits long
Setting the working mode:	
Set valid card only users	3 0 # Entry is by card only
Set valid card and PIN users	3 1 # Entry is by card and PIN together
Set valid card or PIN users	3 2 # Entry is by either card or PIN (default)
To add a user in either card or PIN mode, i.e. in the 3 2 # mode. (Default setting)	

To add a PIN user	1 User ID number # PIN # The ID number is any number between 1 & 2000. The PIN is any four digits between 0000 & 9999 with the exception of 1234 which is reserved. Users can be added continuously without exiting programming mode as follows: 1 User ID no.1 # PIN # User ID no.2 # PIN #
To delete a PIN user	2 User ID number # Users can be deleted continuously without exiting programming mode
To change the PIN of a PIN user (This step must be done out of programming mode)	* ID number # Old PIN # New PIN # New PIN #
To add a card user (Method 1) This is the fastest way to enter cards, user ID number auto generation.	1 Read card # Cards can be added continuously without exiting programming mode
To add a card user (Method 2) This is the alternative way to enter cards using User ID Allocation. In this method a User ID is allocated to a card. Only one user ID can be allocated to a single card.	1 ID number # Read card # User can be added continuously without exiting programming mode
To add a card user (Method 3) Card number is the last 8 digits printed on the back of the card, user ID number auto generation	1 Card number # User can be added continuously without exiting programming mode
To add a card user (Method 4) In this method a User ID is allocated to a card number. Only one user ID can be allocated to the card number	1 ID number. # Card number. # User can be added continuously without exiting programming mode
To delete a card user by card. Note users can be deleted continuously without exiting programming mode	2 Read Card # #
To delete a card user by user ID. This option can be used when a user has lost their card	2 User ID # #

To delete a card user by card number. This option can be used when the user want to make the change but the card has lost	2 Card number # # Note users can be deleted continuously without exiting programming mode
To add a card and PIN user in card and PIN mode (3 1 #)	
To Add a card and PIN user (The PIN is any four digits between 0000 & 9999 with the exception of 1234 which is reserved.)	Add the card as for a card user Press # to exit from the programming mode Then allocate the card a PIN as follows: * Read card 1234 # PIN # PIN # * Read Card Old PIN # New PIN # New PIN #
To change a PIN in card and PIN mode (Method 1) Note that this is done outside programming mode so the user can undertake this themselves	* Read Card Old PIN # New PIN # New PIN #
To change a PIN in card and PIN mode (Method 2) Note that this is done outside programming mode so the user can undertake this themselves	* ID number # Old PIN # New PIN # New PIN #
To delete a Card and PIN user just delete the card	2 User ID # #
To add a card user in card mode (3 0 #)	
To Add and Delete a card user	The operating is the same as adding and deleting a card user in 3 2 #
To delete All users	
To delete ALL users. Note that this is a dangerous option so use with care	2 0000 #
To unlock the door	
For a PIN user	Enter the PIN, then press #
For a card User	Read card
For a card and PIN user	Read card then enter PIN #
11.2 Door Settings	
Relay Output Delay Time	
To set door relay strike time	* Master code # 4 0-99 # # 0-99 is to set the door relay time 0-99 seconds

Door Open Detection	
<i>Door Open Too Long (DOTL) warning.</i> When used with an optional magnetic contact or built-in magnetic contact of the lock, if the door is opened normally, but not closed after 1 minute, the inside buzzer will beep automatically to remind people to close the door and continue for 1 minute before switching off automatically.	
<i>Door Forced Open warning.</i> When used with an optional magnetic contact or built-in magnetic contact of the lock, if the door is forced open, or if the door is opened after 20 seconds, the inside buzzer and alarm output will both operate. The Alarm Output time is adjustable between 0-3 minutes with the default being 1 minute.	
To disable door open detection. (Factory default)	6 0 #
To enable door open detection	6 1 #
Alarm output time	
To set the alarm output time (0-3 minutes) Factory default is 1 minute	5 0-3 #
Keypad Lockout & Alarm Output options. If there are 10 invalid cards or 10 incorrect PIN numbers in a 10 minute period either the keypad will lockout for 10 minutes or both the alarm and the inside buzzer will operate for 10 minutes, depending on the option selected below.	
Normal status: No keypad lockout or alarm (factory default)	7 0 # (Factory default setting)
Keypad Lockout	7 1 #
Alarm and inside buzzer operate	7 2 #
To remove the alarm	
To reset the Door Forced Open warning	Read valid card or Master Code #
To reset the Door Open Too Long warning	Close the door or Read valid card or Master Code #

12. The unit operating as a Wiegand Output Reader

In this mode the unit supports a Wiegand 26 bit output so the Wiegand data lines can be connected to any controller which supports a Wiegand 26 bit input.

